

Modular Cooking - Meritus

Electric - Fry Top

NEFT 4-75 G (ME)



Due to continuous technical development, the image shown may not represent the latest design of the unit.

DESCRIPTION

Modular electric fry top with grooved griddle powered with 5.2 kW Steady State Surface (SSS) heaters. Equipped with open cabinet.

Usable for contact grilling and starch cooking.

Made of AISI 304 with 1.5 mm top thickness, griddle is made of 20 mm thick AISI 420, knife steel, that prevent rust and deliver good thermal conductivity. Designed with large drain for large turner size up to 12 cm. Powered with SSS (Steady-State Surface) that deliver superior temperature distribution and durability.

OTHER AVAILABLE MODELS

- NEFT 6-75 S (ME)
- NEFT 8-75 S (ME)

MAIN FEATURES

- Powered with 5.2 kW SSS heaters.
- Grooved griddle surface with 304 x 545 mm cooking area.
- Fully welded griddle constructed of AISI 420 with thickness of 20 mm, preventing rust.
- Obround drain with oil collection drawer included.
- Temperature control from 50 degree Celcius to 300 degree Celcius.
- Thermal-cut off when overheated.

CONSTRUCTION

- External construction entirely with AISI 304.
- Top panel with 1.5 mm thickness. Orbital surface finishing: resistant toward scratches.
- Front panel is constructed of 0.8 mm AISI 304 with satin surface finish.
- Side panel is constructed of 0.8 mm AISI 304 with satin surface finish.
- Adjustable +/- 25 mm AISI leg.
- Nayati connection system between Meritus products on the front panels, cabinets, and splashbacks.
- Cabinet executed with H2 radius.
- Deep drawn front panel to minimize liquid penetration to the internal part.
- Gasket protection behind the knobs to prevent water to seeping in, prolonging main heating regulation parts.
- IPX5 water protection level.

INCLUDED ACCESSORIES

- 1/3 GN food pan for grease waste.

OPTIONAL ACCESSORIES

- Power cable, H07RN-F (5 x 2.5 mm) p/mtr.
- Joint clip ME.
- Swing door 4-75 ME.

FRONT

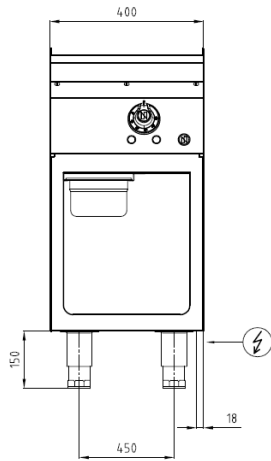

TOP

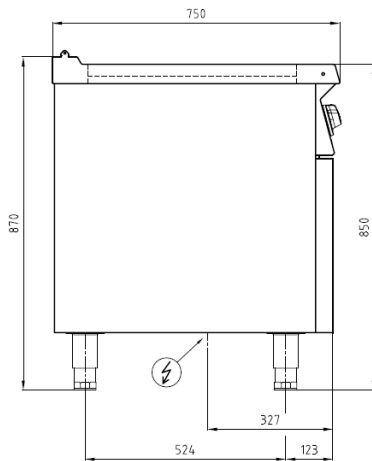

SIDE

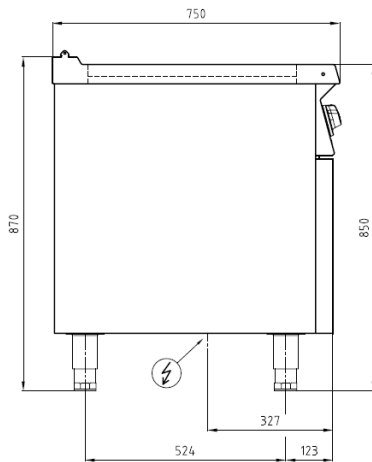

*Overall dimension in mm

TECHNICAL DATA

External Dimensions

Width : 400 mm
 Depth : 750 mm
 Height : 850/870 mm

Cooking Surface

Cooking zones : 304 x 545 mm
 Heating zones : 1
 Control type : Modulating temperature control

Electrical Supply Data

Total connected load : 5.2 kW
 Voltage : 400V, 3NPE AC /50-60Hz
 Recommended fuse : 16 A (slow)

Connections

Water : N/A
 Drain : N/A

Heat & Steam Emissions

Direct heat emission : 1.7 kW
 Latent heat emission : 2.0 kW
 Steam emission : 3.0 kg/h

PACKAGING DATA

Width : 430 mm
 Depth : 780 mm
 Height : 990 mm
 Volume : 0.33 m³

WEIGHT

Net Weight : 60 kg
 Gross Weight : 74 kg